

MannTek

DEC

Dry Evotek Couplings

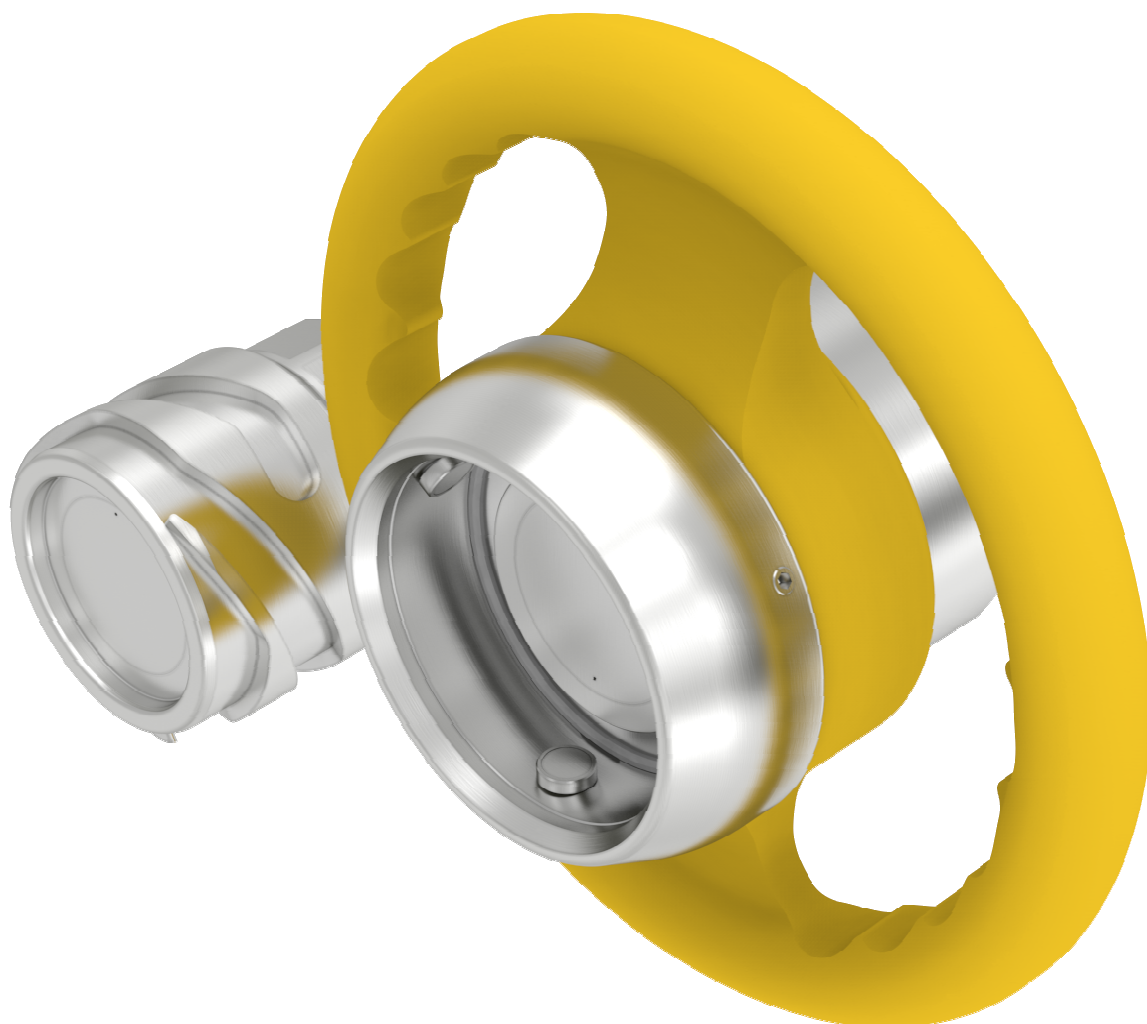

for the chemical industry

ООО «ТИ-СИСТЕМС» ИНЖИНИРИНГ И ПОСТАВКА ТЕХНОЛОГИЧЕСКОГО ОБОРУДОВАНИЯ
Интернет: www.tisys.ru www.tisys.kz www.tisys.by www.tesec.ru www.ти-системс.рф
Телефоны: +7 (495) 7774788, 7489626, (925) 5007155, 54, 65
Эл. почта: info@tisys.ru info@tisys.kz info@tisys.by

DEC – Dry Evotek Couplings stands for another generation of dry disconnect couplings, that is specially made for use in the chemical industry. The external cam curve is ergonomically designed and allows coupling against pressure in the tank unit. Rotating the coupling 120° clockwise opens the valves where the high engagement between hose and tank unit ensures a strong connection.

If the coupling halves are disconnected, their inner valves close the line securely. Once coupled, the valves open the flow cross-section with minimum pressure loss. No moving parts interfere with the flow, which makes cleaning easier. Turning the coupling counter clockwise, the valves close due to spring force. Continuing to rotate will separate the coupling halves without significant effort.

The advantages:

- Low connecting forces even against pressure
- Ergonomic handle (DN40 and bigger)
- Good transmission ratio in the cam curve
- Wide range of chemical resistance due to selection of high quality materials
- Minimized spillage during decoupling

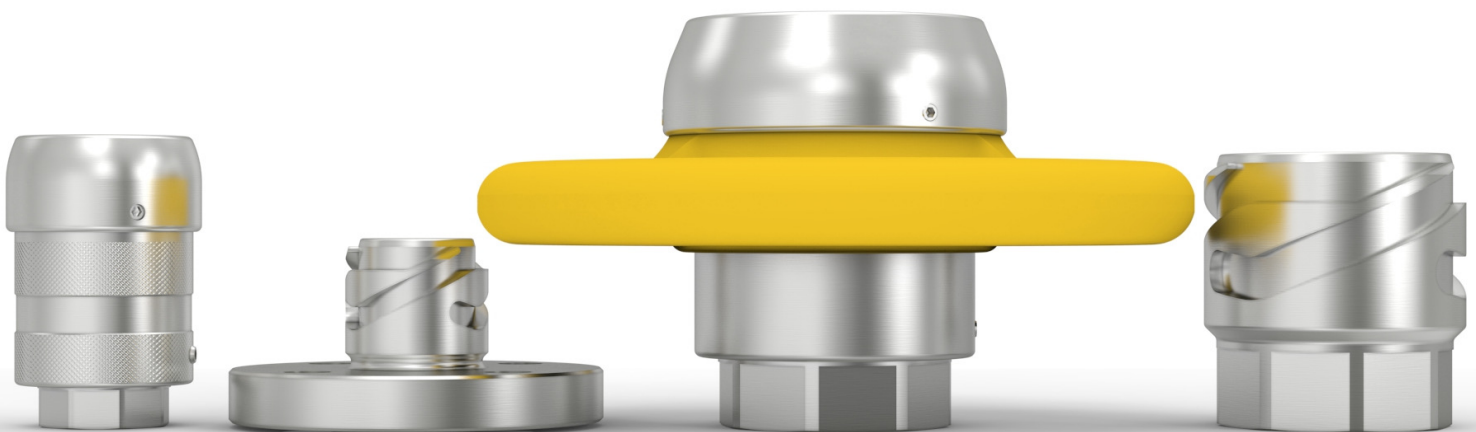

Technical data:

Sizes:

- ✦ DN25, DN32, DN40, DN50 and DN80
- Others on request

Materials:

- ✦ Stainless Steel 1.4404
- ✦ Handle PE (DN40 and bigger)
- Others on request

Connections:

- ✦ BSP female thread
- ✦ Flange EN1092 (DIN) integrated
- Others on request

Seals:

- ✦ O-Rings: FPM, NBR, EPDM, FFKM
- ✦ FDA on request
- ✦ Thread seal PTFE
- Others on request

Accessories:

- ✦ Dustcap
- ✦ Dustplug
- Special options on request

Approvals:

- ✦ Approved acc. to PED 2014/68/EU 4.3
- ✦ Approved acc. to ATEX 2014/34/EU Category 3G

Pressure drop curves:

Pressure drop [bar]

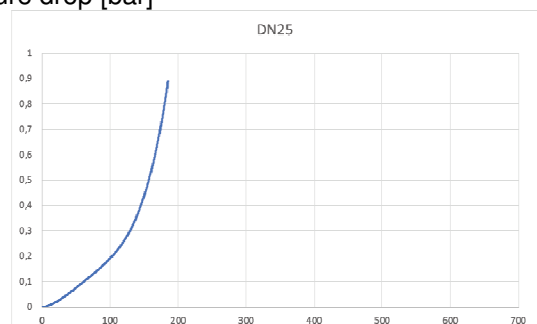

Flow rate [l/min]

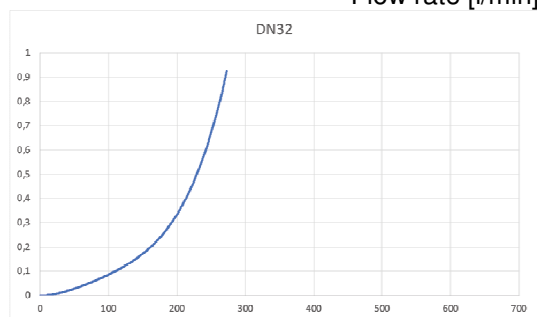

Flow rate [l/min]

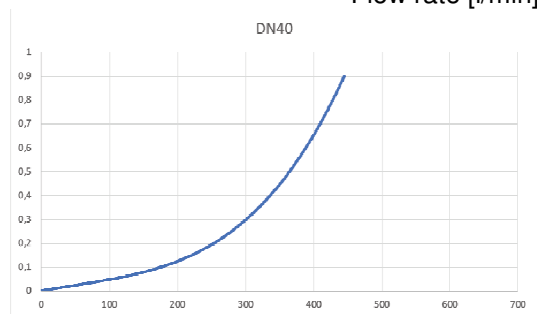

Flow rate [l/min]

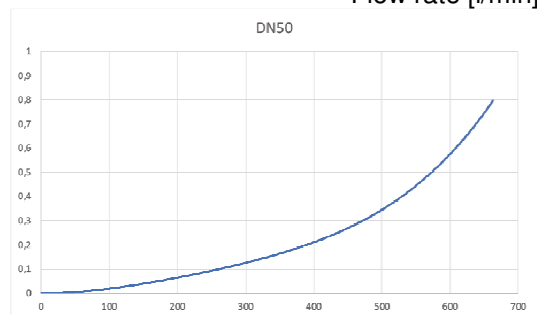

Flow rate [l/min]

Test fluid: Water

Temperature: 20°C

Dimensions:

Hose unit BSP female thread:

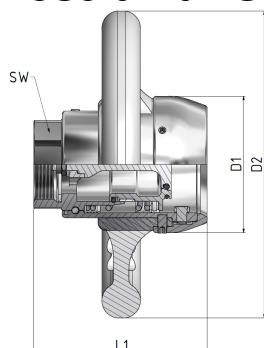

	∅	D1	D2	L1	SW	Weight	Art.-No.
"	DN	mm	mm	mm		kg	
1	25	59,5	54,5*	90	38	0,82	SS103A4401A
1 1/4	32	76	66*	105	48	1,35	SS105A4401A
1 1/2	40	89	200*	113	56	2,61	SS207A4401A
2	50	106	220*	126	68	2,80	SS210A4401A
3	80						SS414A4401A

*DN25 and DN32 with knurled sleeve, DN40 and DN50 with handwheel

Hose unit flange EN1092 PN10/16:

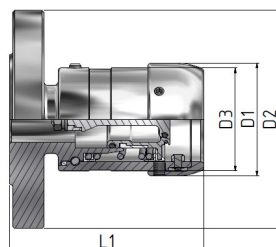

	∅	D1	D2	D3	L1	Weight	Art.-No.
"	DN	mm	mm	mm	mm	kg	
1	25	59,5	115	54,5*	103	2,07	SS123A4401
1 1/4	32	76	140	66*	115	3,14	SS125A4401
1 1/2	40	89	150	200*	134	4,74	SS227A4401
2	50	106	165	220*	140	5,29	SS230A4401

*DN25 and DN32 with knurled sleeve, DN40 and DN50 with handwheel

Tank unit BSP female thread:

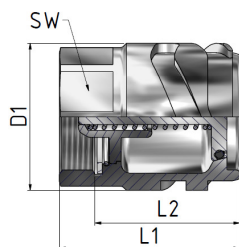

	∅	D1	L1	L2	SW	Weight	Art.-No.
"	DN	mm	mm	mm		kg	
1	25	44	53	42	38	0,29	TS103A4401A
1 1/4	32	54	65	54	48	0,51	TS105A4401A
1 1/2	40	62,5	76	61	56	0,77	TS207A4401A
2	50	80	84	66	68	1,20	TS210A4401A
3	80						TS414A4401A

Tank unit flange EN1092 PN10/16:

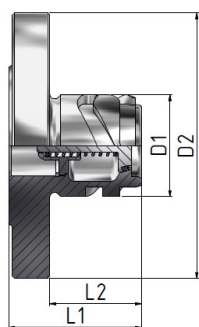

	∅	D1	D2	L1	L2	Weight	Art.-No.
"	DN	mm	mm	mm	mm	kg	
1	25	44	115	58	40	1,50	TS123A4401
1 1/4	32	54	140	70	52	2,25	TS125A4401
1 1/2	40	62,5	150	72	54	2,68	TS227A4401
2	50	80	165	80	62	3,48	TS230A4401

Standard sealing material FPM, others on request.

How it works

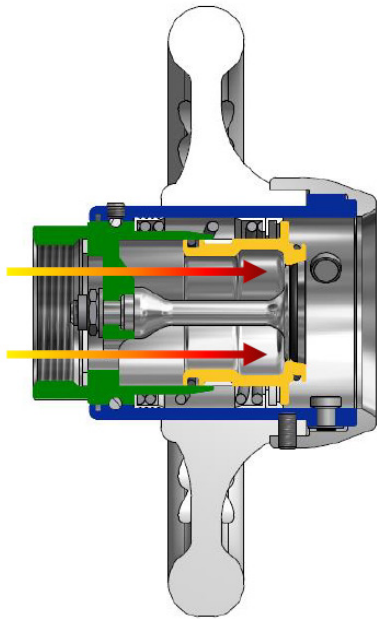

DEC Hose unit
disconnected + closed

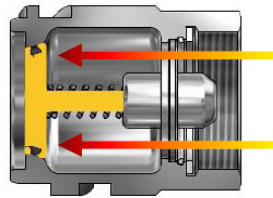

DEC Tank unit
disconnected + closed

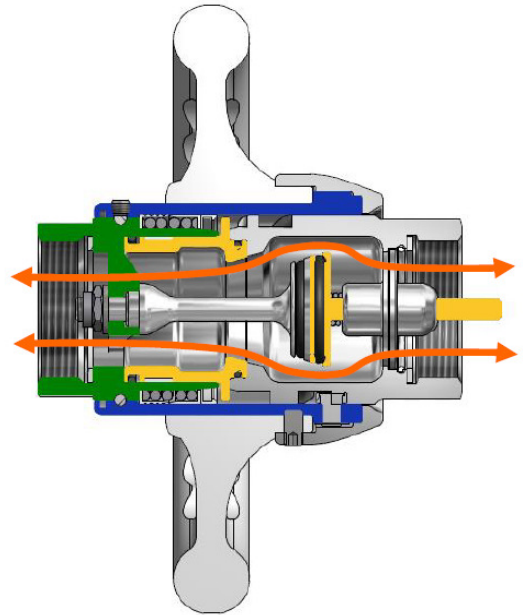

DEC HU + TU
connected + open

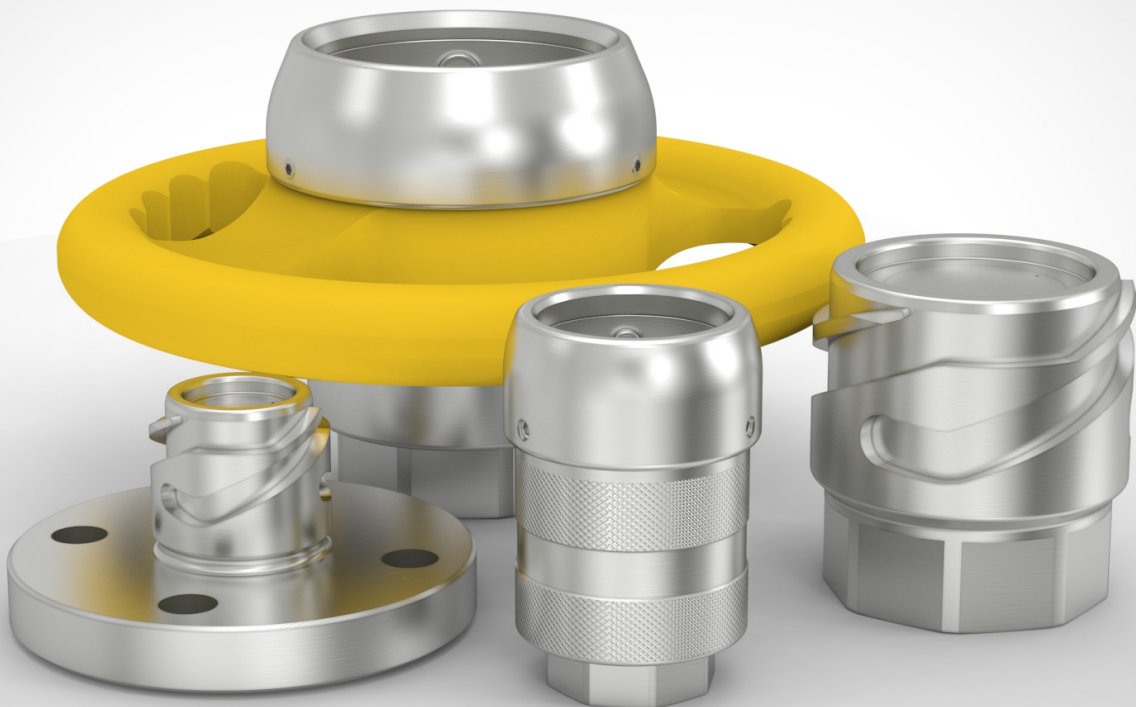



MannTek is the world market leader in spill-free coupling technology, with more than 20 years of experience from demanding applications. We design and manufacture specialized equipment for safe and environmentally friendly handling of aggressive fluids under harsh climatic conditions, servicing demanding clients all over the world. Our dedication to constant development and improvement makes our couplings the logical choice wherever quality and safety matter.



MannTek

Company Approvals



ClassNK



Mann Teknik AB
is a certified
ISO 9001-company

ООО «ТИ-СИСТЕМС» ИНЖИНИРИНГ И ПОСТАВКА ТЕХНОЛОГИЧЕСКОГО ОБОРУДОВАНИЯ
Интернет: www.tisys.ru www.tisys.kz www.tisys.by www.tesec.ru www.ти-системс.рф
Телефоны: +7 (495) 7774788, 7489626, (925) 5007155, 54, 65
Эл. почта: info@tisys.ru info@tisys.kz info@tisys.by